

USER MANUAL

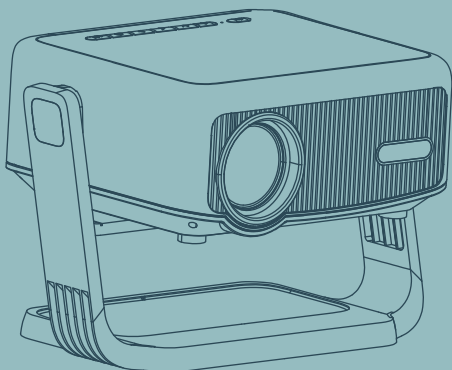

L02 MINI VIDEO PROJECTOR

Where Quality Meets Innovation

✉ Support_us@lisowod.com

🌐 <https://lisowod.com>

☎ US: (971) 337-8504(Phone&Text)

W240408

CONTENTS

CONTACT US	001
TROUBLESHOOTING	002
PACKING LIST	004
FUNCTION OVERVIEW	005
REMOTE CONTROL	007
INPUT SOURCE	008
WIRELESS CONNECTION METHOD	009
-Wireless projection.....	009
-Bluetooth connection.....	012
PROJECTOR IMAGE SETTINGS	014
-Zoom Function.....	014
-Keystone Correction.....	015
-Electric-focus.....	016
INSTALLATION	017
SETTING MENU	019
PROJECTOR SPECIFICATIONS	023

We continuously improve our products.
Images and descriptions in the manual are for reference
only and may differ from the actual products.
Please refer to the actual products for accuracy.
You can get the latest version through online upgrades.
Thank you for your understanding.



Activate Your 3-year Warranty and Exclusive Surprise

Ladies and Gentlemen

Thank you for purchasing **L02** Projector. Please take 1 minute to scan the code and activate your **3 year warranty**.



It is recommended to complete the process within **3 days**.

Tips: If you find that you cannot activate your warranty by scanning the code, you can contact us via the email below, and we will help you activate your warranty for you.

✉ US: Support_us@lisowod.com

✉ EU: Support@lisowod.com

✉ JP: Support_jp@lisowod.com

🌐 <https://lisowod.com>

📞 US: (971) 337-8504 (Phone/Text)

WE ARE

constantly optimizing and upgrading our products, the pictures and descriptions in the manual are for reference only may differ from the actual product, please refer to the actual product. You can get the latest version through online upgrade. Thank you for your understanding. Product warranty and support are provided if products have been purchased from our authorized seller. In order to protect your rights, you can also send an email to LISOWOD official email US:Support_us@lisowod.com [EU: Support@lisowod.com](mailto:EU:Support@lisowod.com) to verify the authenticity of your L02.

Our High qualified and responsible customer service team is waiting to hear from you and answer any of your questions **24/7**.

We are happy to receive your message about the problems you met so that we can help you to get out of the trouble. We are even happier to hear your praise about our wonderful projector and to see the happy moments our projector have brought to your life!

The fastest and most efficient way to contact us?

Method 1- Via email & phone:

US:Support_us@lisowod.com

US: (971) 337-8504 (Phone/Text)

[EU: Support@lisowod.com](mailto:EU:Support@lisowod.com)

[JP: Support_jp@lisowod.com](mailto:JP:Support_jp@lisowod.com)

Method 2:

Your Orders > The order has a problem > Choose a topic from list displayed > Select Contact seller

Please come. Please~~~

<https://lisowod.com>



CONTACT US

Thank you very much for supporting Lisowod! Hope our products and services bring you a pleasant journey of audio-visual enjoyment. Lisowod promises a 3-Year Warranty and Lifetime Technical Support, please do not worry when encountering any problems. **Any buyer with any questions who comes to contact us will have our promise to get a satisfactory solution + an Extra 6-Month Warranty to thanks for your support!**

By the way, we are racking our brains to develop a new projector. If you have any ideas about projector, such as user experience, parameters, features, colors and appearance, we warmly invite you to tell us in detail. We value all voices, and you won't imagine how much we look forward to your ideas. **Once your idea is adopted, as a thank you, I will apply to send one to you for FREE as the first tester when the new product is developed.**

Looking forward to your messages!
Onoayo Support Team

Scan QR code below, start chatting with us!!!

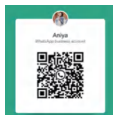

US:WhatsApp

Scan this code, learn how to operate the projector visually on YouTube!!!



LISOWOD

US: Support_us@lisowod.com



EU: Support@lisowod.com



Official website: <https://lisowod.com>



US: (971) 337-8504 (Phone/Text)



TROUBLE SHOOTING

Our high-qualified customer services team is waiting to hear from you and answer any of your questions 24 hours a day and 7 days a week. We are happy to receive your message about the problems you met so that we can help you to get out of the trouble. You can contact us through email:

US: Support_us@lisowod.com

EU: Support@lisowod.com

Q: Where can I find the instructional videos on how to set up the projector?

A: We have prepared detailed operation videos on YouTube, which contains almost every step of operating the projector, like wifi connection, wired connection and so on. Just search "Lisowod" on YouTube and you will find it.

Q: I received the projector but it has no remote control. Could you send it to me?

A: If the product you receive is missing any accessories, please let us know what accessory do you miss. We will send them to you as soon as possible.- Just contact us via our e-mail:

US:Support_us@lisowod.com/EU: Support@lisowod.com

Q: I can't find the focus ring on the projector,how can I adjust the focus?

A: This mini projector support electric-focus with remote control,just need to press the "F+"&"F-" on the remote.Note: Projector and screen/wall must be in effective distance.

Q: The remote control is unresponsive.

A: ① Make sure remote points at IR receiver directly.

② Do not cover IR receiver.

③ Make sure you have put the battery in,this remote control does not come with batteries.

Q: My projector and smartphone are connected to the same WiFi, but when I want to do screen mirroring, the projector's name is not detected.

A: ① Please initialise the projector and reconnect it to your smartphone.

② Please disconnect from the connected network and enter the password again to connect.

③ Try connecting the smartphone and the projector to the Internet once using a hotspot.

If the above methods do not solve the problem, please contact the customer service.

Q: I can't play Netflix video on the projector, why?

A: There are quite a few video platforms like Netflix, Disney+ and Hulu are under HDCP copyright protection, and thus do not support being displayed on a projector, this is the same situation for all projectors. You would need a TV stick to enjoy these video platforms.

Q: Up Side Down Images.

A: Enter [Set], then enter [projector setting] to flip the projection image.

Q: I contact the customer service team as suggested, but has not received any reply. Why?

A: We promise that we will reply to all the emails within 24 hours. If you haven't received any reply from us more than one day, then maybe our email has been blocked or has gone to the spam email box. Please send us email again or contact us by Whatsapp or Facebook.

Q: Hello,could you tell me what the size of the mounting screw is at the bottom of the projector? I am struggling to find a stand.

A: The size of the mounting screw 1/4 inch, approx. 6.35mm diameter.

PACKING LIST

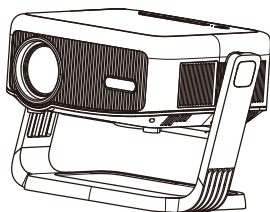

L02



Remote



User Manual



HD Cable

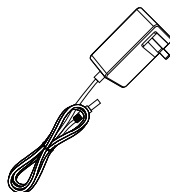

Power Cable

NOTICE

Recommended

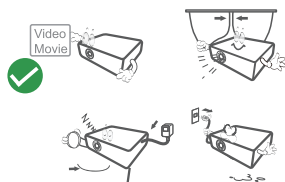

Not Recommended

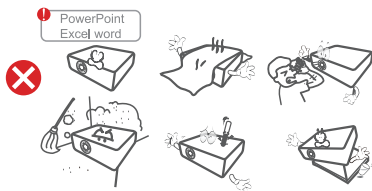

FUNCTION OVERVIEW

Top View

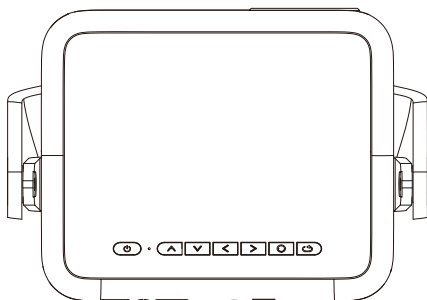

Button illustrate

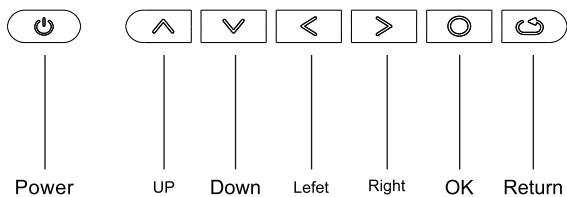

Front View

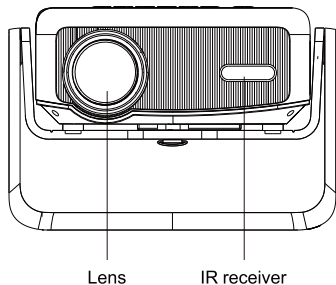

Rear View

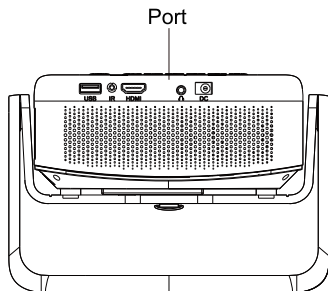

REMOTE CONTROL

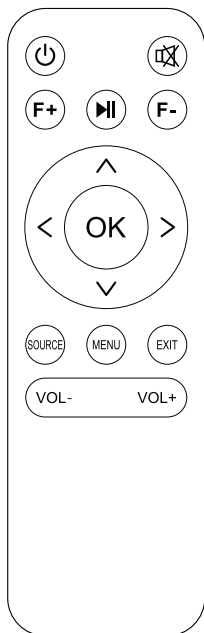

Power button:
Turn on/off



Mute button:
Mute



Focus button:
Adjust focal distance



Signal source button:
Choose to enter the Application Center, HDMI



Exit button:
return to last step



Source button:
enter the setting page



Home button:
short press and return to the homepage



Direction Buttons:
 ^ Up v Down
 < Left > Right
 ● OK



Volume button:
Volume-, Volume+

Installation of the remote control

1. Install 2 pieces of AAA batteries into the remote before using it. Do not combine new batteries with old ones in a remote controller, which can cause operation failure due to insufficient power supply.
2. When using the remote controller, please make sure that the signal transmitter of the remote controller aims at the infrared signal receiver of the projector.

INPUT SOURCE

Press on this button  on the projector remote to enter the interface of input source.

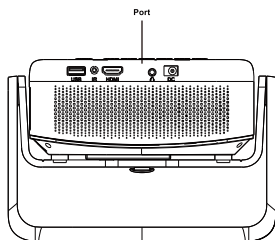

HDMI Connection

When the HDMI cable is plugged in, press the button  on the remote and select the [HDMI] mode, then select [HDMI] from the homepage to play the video.

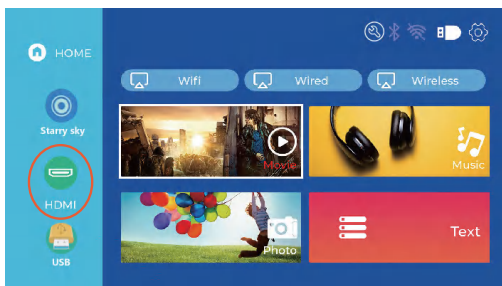
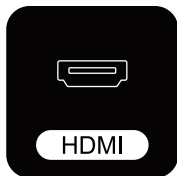

USB Connection

When the U disk is plugged in, and entering the Media, you can play any document in your USB disk.



Speaker/Headphones Connection

Directly connect the wired speaker and your headphones/earphones to the Audio Out port on the projector with a 3.5mm audio cable.



WIRELESS CONNECTION METHOD

Warming Tips:

- ① The fluency of screen mirroring with wireless connection will be affected by the network environment. A bandwidth of 100Mbit or more is recommended when using screen mirroring.
- ② Make sure your mobile device is close to the projector when using wireless connection. A distance within 1 meter is recommended.
- ③ Some mobile devices may not support screen mirroring due to the compatibility.
- ④ Any questions, please feel free to email LISOWOD via
US:Support_us@lisowod.com
US: (971) 337-8504 (Phone/Text)
EU: Support@lisowod.com
JP: Support_jp@lisowod.com

Wireless projection

Step 1 : Connect Projector to your Home WiFi

Go to set page -- Select the [WIFI] Select your home WiFi from the list -- Connect the projector to your home WiFi.

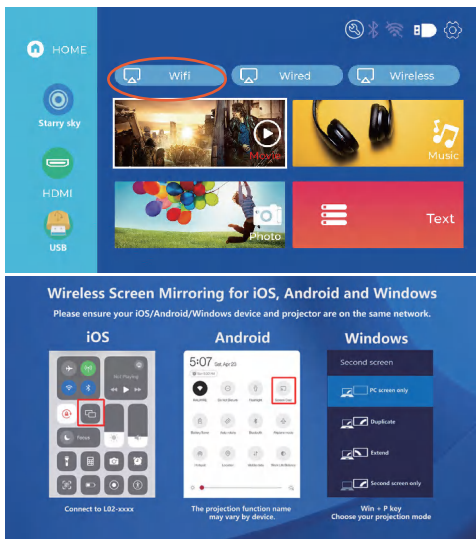

For wireless Devices:

Go to Home page-- Select the [wireless]- - Follow the steps as the picture,and open your device's projection page--Select your device from the list --Connect the projector with your device.

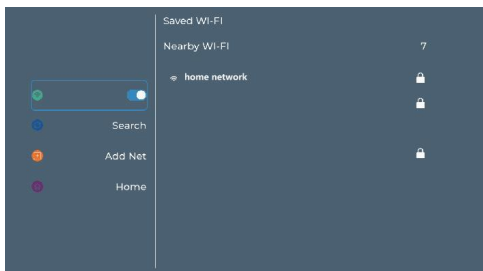
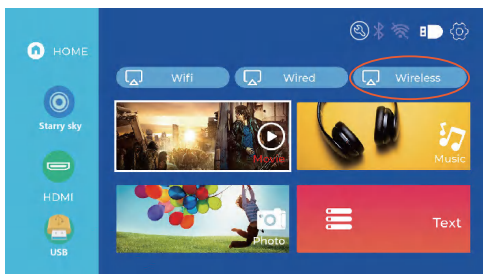

For Cable device

Go to Homepage of the projector and select [Wired] to enter the screen mirroring interface , and follow the step.

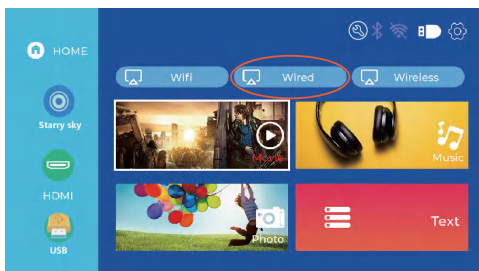

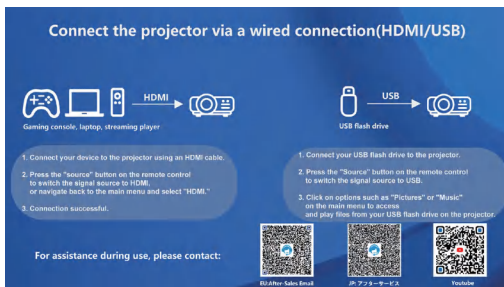

For APP Screen Cast

Step1: Please keep your device and projector on the same network.

Step2: Go to Homepage of the projector and select [Wireless] to enter the screen mirroring interface.

Step3: Open the screen projection app

Step4: Find the "Screen Cast" or "Wireless Projection" button

Step5: Then select the device name that appears on the projector screen from the searching list.

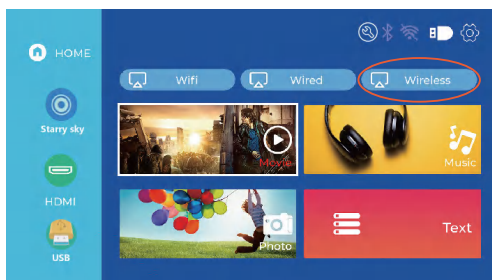

Bluetooth connection

Go to the home page, click the " Set " to go to the Setting page. Choose the logo of [BT] to enter the BT function.

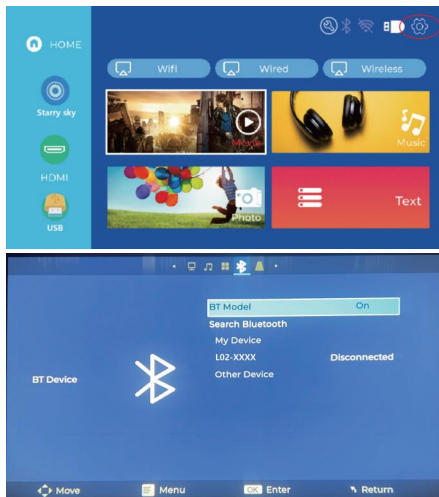

1.Connect the projector to an external Bluetooth speaker.

In BT setting page, select Bt mode "on", press OK button to open BT, then select "Search Bluetooth" button to scan available devices. and then select "Search Bluetooth" button to scan for available devices.Select the correct Bluetooth device name and press OK button to pair.

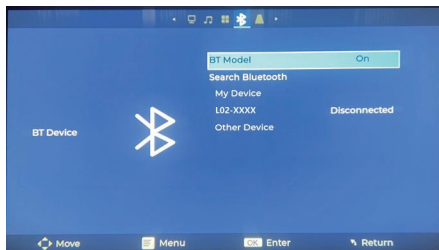

2.Connect your phone to the projector using Bluetooth.

On the Bluetooth settings page, Choose the Bt reception mode and wait on this page. Then use your phone to search and scan for available devices, Choose the rightBluetooth device name, Press OK button to pair.

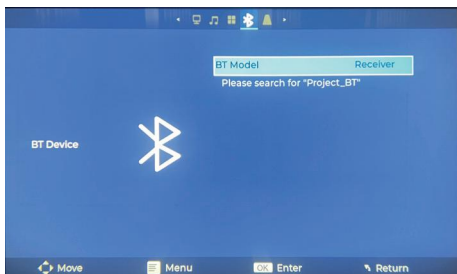

3.Cannot connect Bluetooth speaker?

When the Bluetooth speaker is connected to the projector, it will show up in paired devices ,it means that the projector has been successfully connected.If it shows pairing failed, it means that the Bluetooth speaker has not been connected to the projector.

Please try the following methods:

Method 1: Please click the [UNPAIR] , then connect your BT again.

Method 2: Operate on the projector to turn off Bluetooth (press the "OK" button on the remote control).

Then turn on BT (the "OK" button on the remote control). Reconnect the Bluetooth speaker again.

Method 3: Turn off the projector and restart it, then reconnect the Bluetooth speaker.

Method 4: Restore the factory settings and then reconnect the Bluetooth speakers.

PROJECTOR IMAGE SETTING

Zoom Funtion

Find the settings icon on the main page, click it to enter the settings list, and find the "Flip" option to set the projection mode. Click the "Windows zoom" option to adjust the zoom ratio, supports 100%-70% zoom.

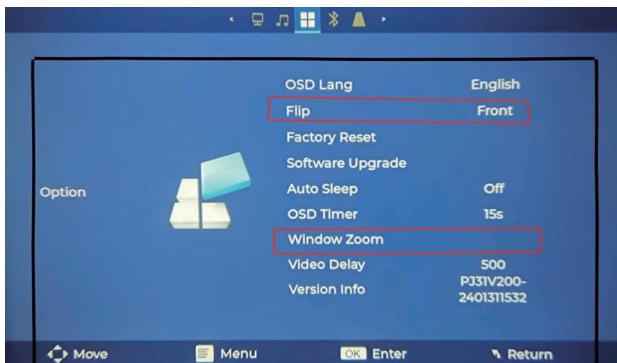
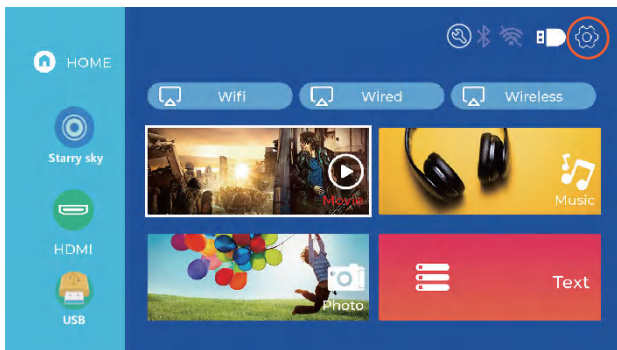

Keystone Correction

Auto & Manual Vertical Keystone Correction & Electric-focus

Find the settings icon on the main page, click it to enter the settings list then you can see every option.

>>Auto Vertical Keystone Correction

For auto vertical keystone correction, simply keep the interface "Vertical automatic correction" in the "on" state, and the projector will automatically correct the image distortion.

>>Manual $\pm 30^\circ$ Vertical Keystone Correction

If you prefer manual keystone correction, you can disable the automatic feature. After that, the "Manual adjustment" will show "on" state then you can adjust the keystone correction degree by using the left and right buttons on the remote control.

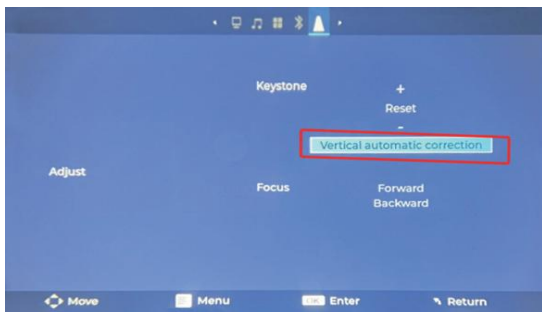
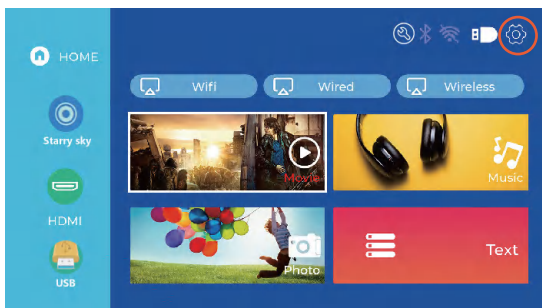

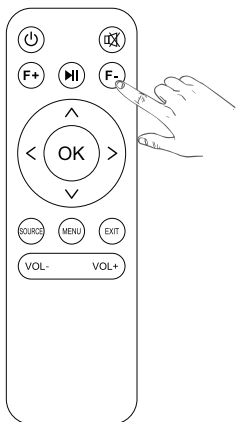
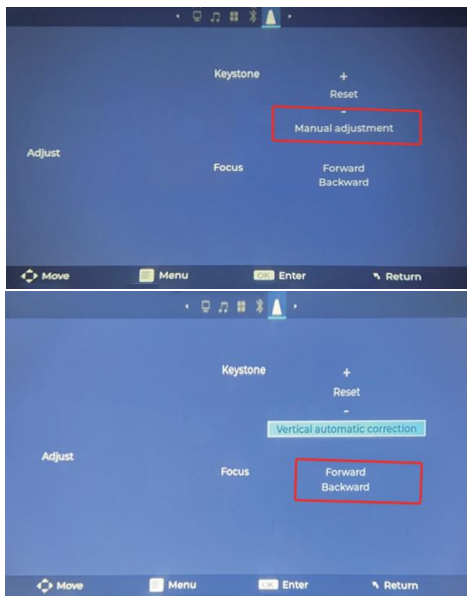

Electric-focus

There are two ways to adjust focus, you can stay in that settings list and adjust focus forward or backward. Another method is to simply use the "F+" "F-" buttons on the remote control to adjust the focus on any interface.

INSTALLATION

Projection Distance and Size

If you want to get a free projection screen, please email us via

US: Support_us@lisowod.com

Please follow the data in chart below, to adjust the image size and the distance.

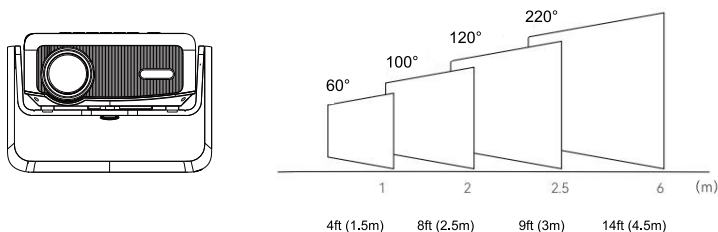

Installation Method

The projector can be hung from the ceiling using a special hanger frame or placed on a stable desk to project the image based on the operating environment and requirements. The installation method is as follows:

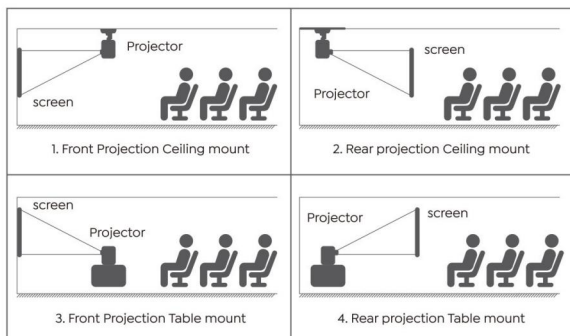

PROJECTOR INSTALLATION

Projector Installation

Note:

the screw hole on the bottom of the projector is compatible with a 1/4-inch screw.

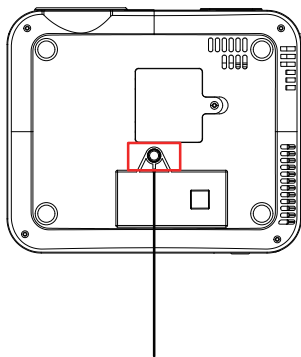
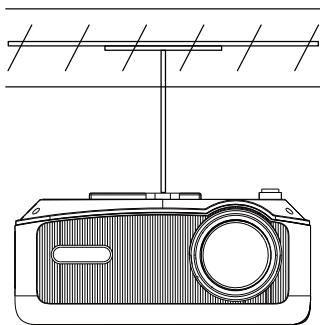

1/4-inch screw hole (diameter 6.35mm)

SETTING MENU

Clicking on the gear icon in the top right corner of the main menu will take you to the settings page, where you can adjust functions such as images and sound.

Picture



Menu	Options	Functions
Image Mode	Standard/Dynamic /Mild/User	Adjust image effects. Selecting "User" enables more customization options.
Contrast	0-100	Set brightness contrast
Brightness	0-100	Adjust screen brightness
Color	0-100	Customize screen colors
Sharpness	0-100	Enhance image sharpness
Color temperature	Cold/Standard/Warm	Light warmth level

Sound

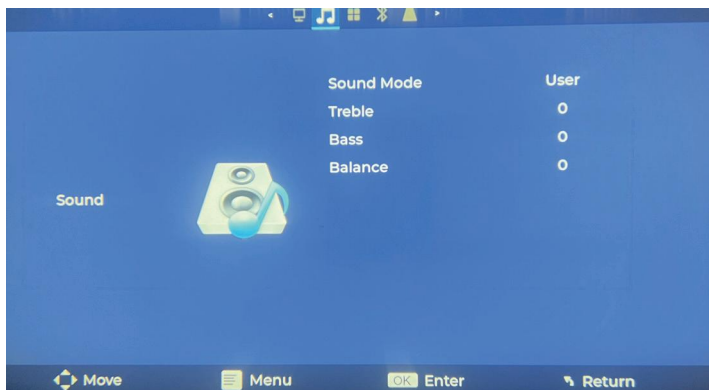

Menu	Options	Functions
Sound Mode	Standard/Music/ Movie/Sports/User	Adjust the sound quality to match the type of video
Treble	0-100	Set for more treble
Bass	0-100	Set for more bass
Balance	0-100	Set the balance from bass to treble

SETTING MENU

Option



Menu	Options	Functions
OSD Language	/	Setting the system language
Flip	Front/Rear on Desk/Front on Ceiling	Selecting the projection method
Factory Reset	/	Restoring factory settings
Software Upgrade	/	System upgrade
Auto Sleep	60m/120m/180m	Automatically turn off the screen
OSD Timer	5s/10s/15s/20s/25s/30s/	Return to the main menu after reaching the set time
Window zoom	/	zoom&screen ratio&reset
Video Delay	0-2000	Adjust the screen delay within a certain range.
Version Info	/	Version number

PROJECTOR SPECIFICATIONS

Imaging technology	LCD
Native resolution	1920*1080
Light source	LED
Focus mode	Electronic focus
Projection distance	3-14ft.
Screen size	40-200 inches
Asoect ratio	16: 9 and 4: 3
Power input	100V-240V-50/60HZ
Input	USB*1/HDMI*1
Output	3.5 mm headphone jack
Unit size	172*143*80mm
Net Weight	0.7kg

*Any buyer with any questions who comes to contact us will have our promise to get a satisfactory solution + an Extra 6 Month Warranty+other surprises to thanks for your support!

US: Support_us@lisowod.com

Phone&Text Support: (971) 337-8504

EU: Support@lisowod.com

NET: <https://lisowod.com>

FCC STATEMENT:

This device complies with Part 15 of the FCC Rules. Operation is subject to the following two conditions:

(1) This device may not cause harmful interference, and (2) This device must accept any interference received, including interference that may cause undesired operation.

Warning: Changes or modifications not expressly approved by the party responsible for compliance could void the user's authority to operate the equipment.

NOTE:

This equipment has been tested and found to comply with the limits for a Class B digital device, pursuant to Part 15 of the FCC Rules. These limits are designed to provide reasonable protection against harmful interference in a residential installation. This equipment generates and can radiate radio frequency energy and, if not installed and used in accordance with the instructions, may cause harmful interference to radio communications.

However, there is no guarantee that interference will not occur in a particular installation. If this equipment does cause harmful interference to radio or television reception, which can be determined by turning the equipment off and on, the user is encouraged to try to correct the interference by one or more of the following measures: Reorient or relocate the receiving antenna. Increase the separation between the equipment and receiver. Connect the equipment into an outlet on a circuit different from that to which the receiver is connected. Consult the dealer or an experienced radio/TV technician for help.

FCC Radiation Exposure Statement:

This equipment complies with FCC radiation exposure limits set forth for an uncontrolled environment. This equipment should be installed and operated with minimum distance 20cm between the radiator & your body.

Lisowod